

Cleanroom Teardrop G2 & Hygeia G2

Sunny Sun

Product Marketing, BG Professional GC & GM

Aug 29th, 2017

Cleanroom Teardrop G2– CR388C

Cleanroom Hygeia G2 – CR488B/ CR488C

Teardrop
CR388C

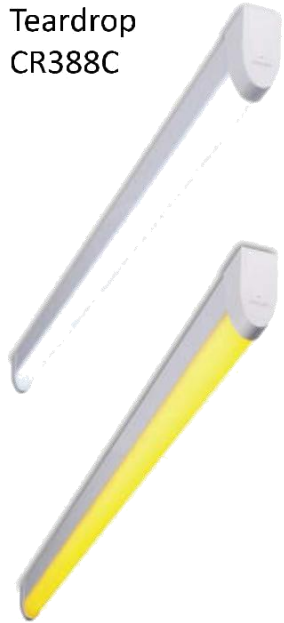

Hygeia
CR488C

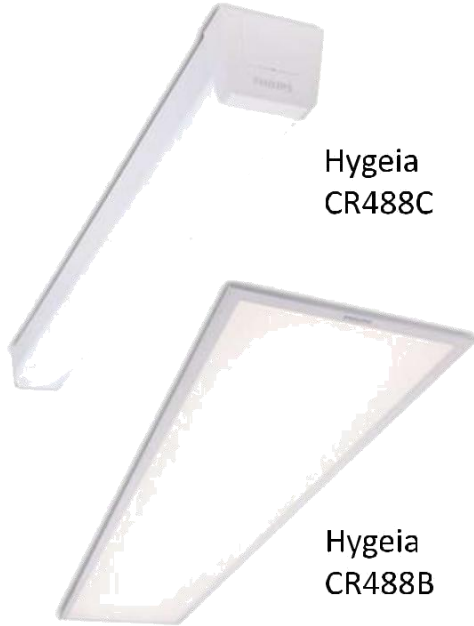

Hygeia
CR488B

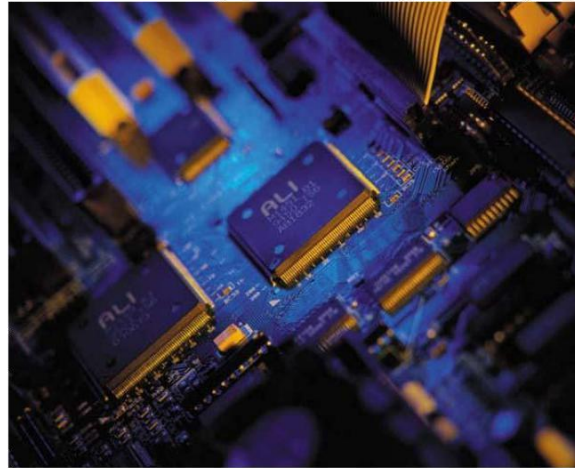

Features & Benefits

- **Robust design with cleanroom certification:** IP40, IK03, cleanroom classification 10 – 1000/ 100 – 10,000.
- **Low glare, soft and uniform light output:** CRI>80, SDCM<5, low flicker option available
- **Reliable quality, low failure rate, long lifetime, free of maintenance:** 50K hours @ L70B50 lifetime,
- **Energy saving, high efficiency green LED solution:** 32W, 3900lm, 120 lm/W. Saving 55% electronic cost comparing with conventional product
- **Easy Installation:** Surface& ceiling installation, track kits available for T-bar installation

Cleanroom Key Application

- Integrated circuit (VLS) manufacturing
- Semiconductor manufacturing/ assembly
- Pharmaceutical/ Medical industry
- Beverage, Food, Drinks filling
- Critical optical devices, optical discs
- Fine mechanical components, aviation instruments, etc.



Cleanroom Key Application - air cleanliness class

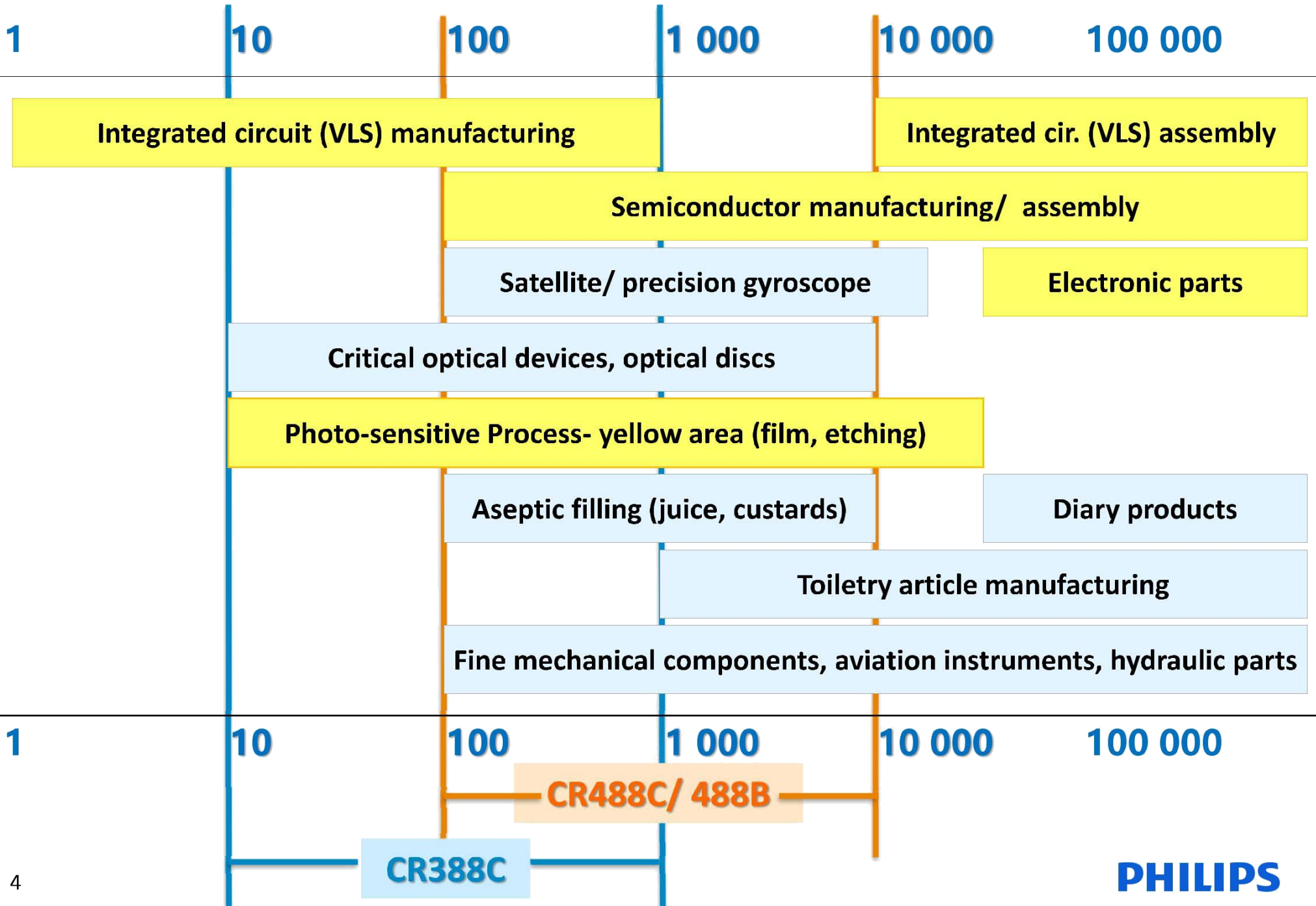

Cleanroom Key Application - air cleanliness class

Air cleanliness class	>" or "=" solid particles diameter (pcs/cubit feet)					
	0.1um	0.2um	0.3um	0.5um	1.0um	5.0um
ISO Class1	10	2				
ISO Class2	100	24	10	4		
ISO Class3	1,000	237	102	35	8	
ISO Class4 10	10,000	2,370	1,020	352	83	
ISO Class5 100	100,000	23,700	10,200	3,520	832	29
ISO Class6 1000	1,000,000	237,000	102,000	35,200	8,320	293
ISO Class7 10,000				352,000	83,200	2,930
ISO Class8 100,000				3,520,000	832,000	29,300
ISO Class9 1,000,000				35,200,000	8,320,000	293,000

CR388C

CR488C
CR488B

Cleanroom Amber lighting Option – CR388C/ CR488C

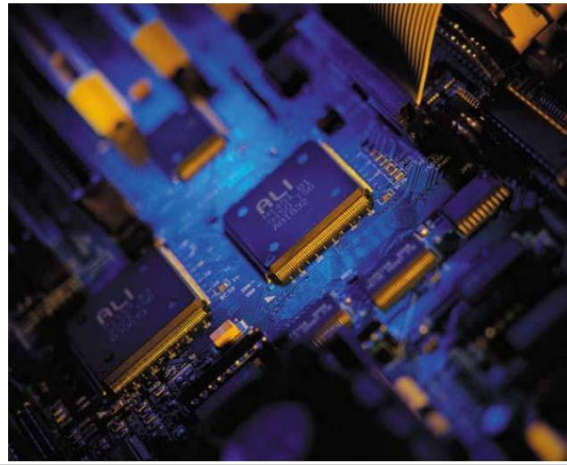
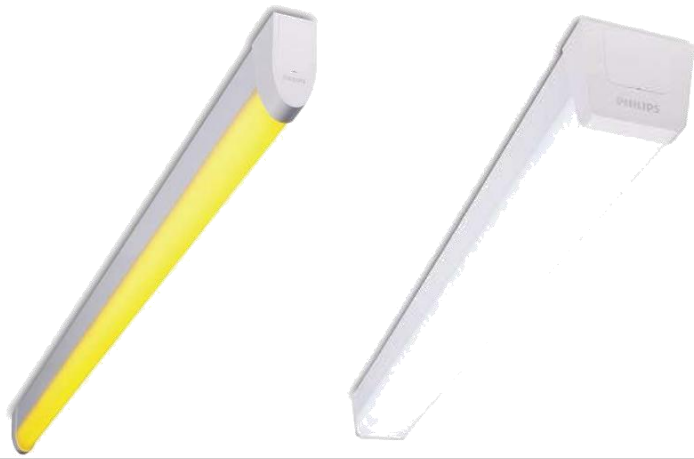

CR388C Amber Option, 0.24% below 505 nm

$$\text{Total radiation content: } E_{\text{total}} = \int_{200}^{1100} E(\lambda) d\lambda = 9196,1 \text{ mW/m}^2$$

$$\text{Radiation content below 505nm: } E_{<505\text{nm}} = \int_{200}^{505} E(\lambda) d\lambda = 22,1 \text{ mW/m}^2$$

$$\text{Radiation percent below 505nm: } E_{<505\text{nm}} / E_{\text{total}} = \int_{200}^{505} E(\lambda) d\lambda / \int_{200}^{1100} E(\lambda) d\lambda = 0,24\%$$

CR488C Amber Option, 0.29% below 505 nm

$$\text{Total radiation content: } E_{\text{total}} = \int_{200}^{1100} E(\lambda) d\lambda = 20419,0 \text{ mW/m}^2$$

$$\text{Radiation content below 505nm: } E_{<505\text{nm}} = \int_{200}^{505} E(\lambda) d\lambda = 58,3 \text{ mW/m}^2$$

$$\text{Radiation percent below 505nm: } E_{<505\text{nm}} / E_{\text{total}} = \int_{200}^{505} E(\lambda) d\lambda / \int_{200}^{1100} E(\lambda) d\lambda = 0,29\%$$

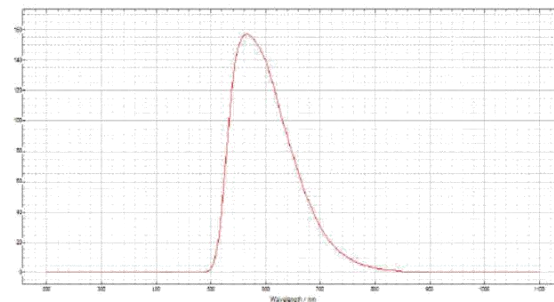
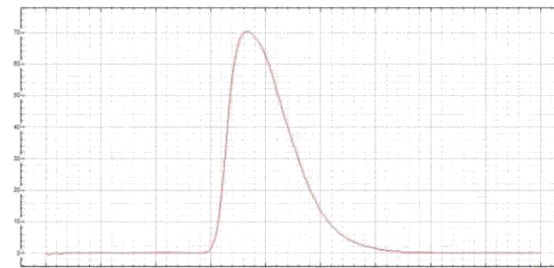
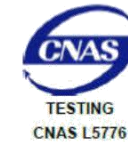

Integral Solution, Perfect "OEMT" System Architecture

High-performance LED module & driver, professional mechanical structure assure the safety and reliability



Philips Xitanium® driver
Peak design driver @ 50000hrs
Power Factor: 0.9 ~ 0.95



Nichia LED chips
CRI >80
Yellow light option available



Sabic PC ed-cap
Bayer optical PC diffuser

Dual extrusion housing
Compact and smooth
No dust attached

High quality SPCC scold rolled steel
Powder coating surface treatment
Optional SUS304 frame

Outstanding optical performance

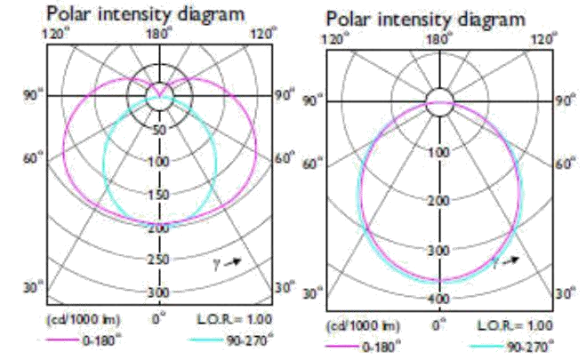
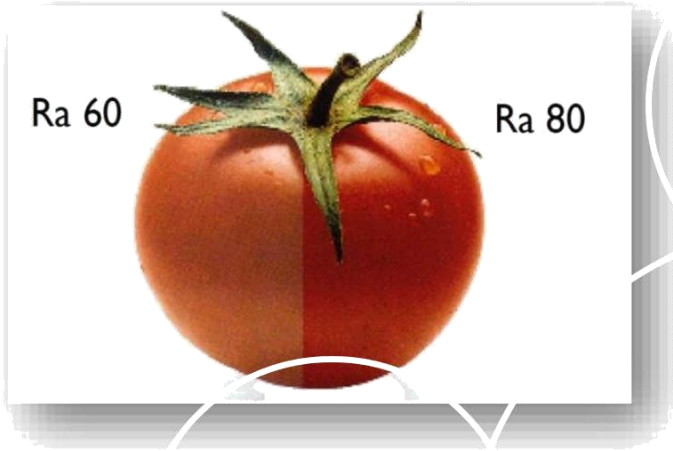

Smooth Housing Design to Avoid Dust Attached

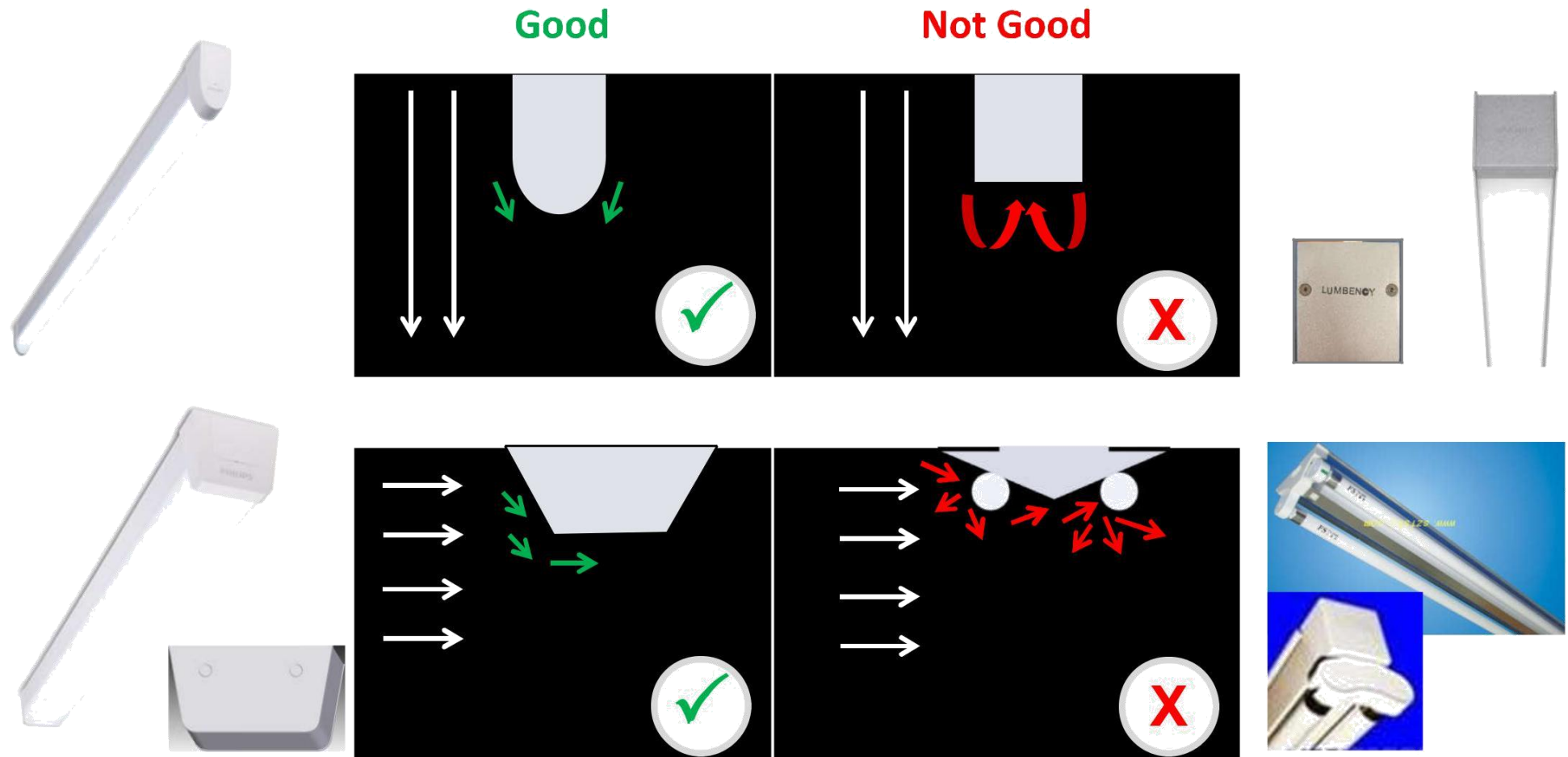

- The simpler the shape, the smoother the air flows; vice versa
- The smoother the surface, the smoother the air flow; vice versa

Comparing with conventional & T-LED product

1. Slim, flat surface, avoiding dust attaching
2. Soft and comfortable light

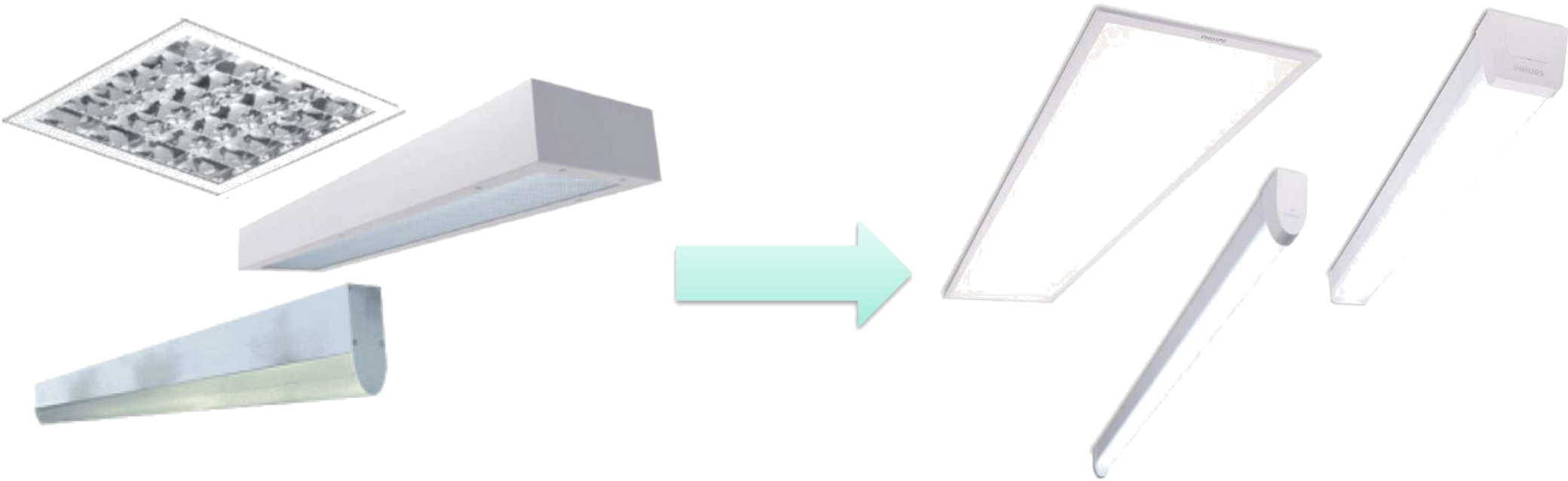

3. Energy saving, long lifetime, reliable



Verified and tested on system level
Reliable EE components



Vertical air flow reaching class 10 or higher – CR388C

Teardrop G2 CR388C (classification 10 - 1000)

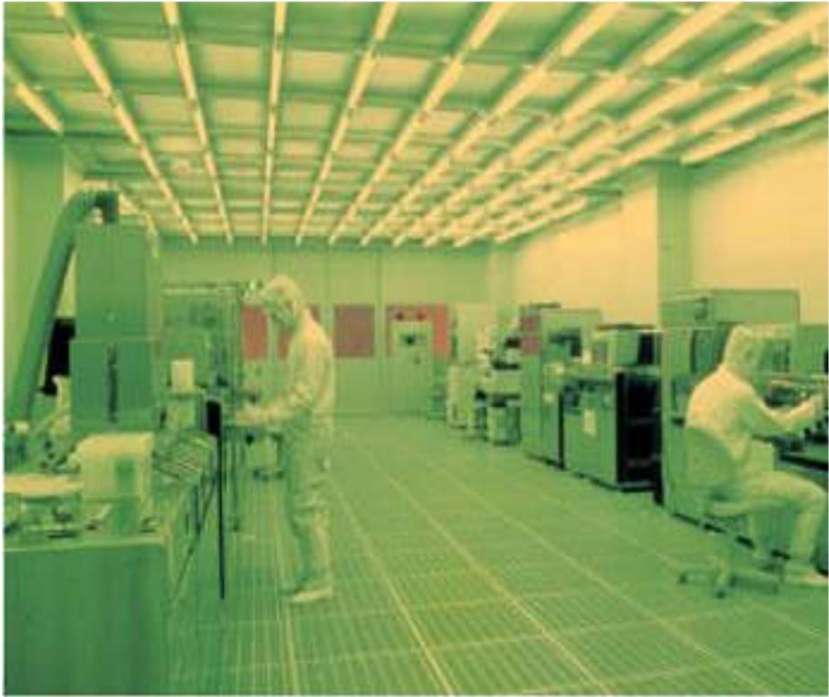
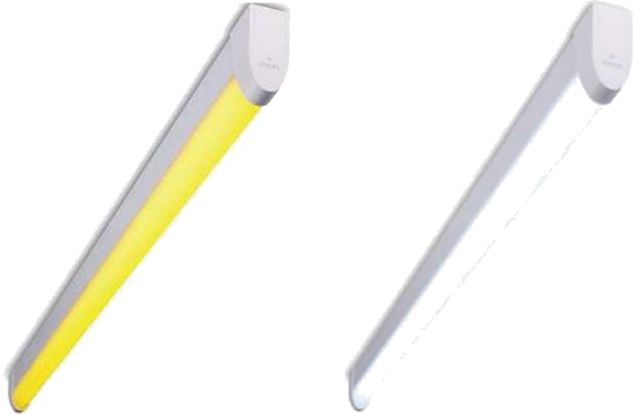
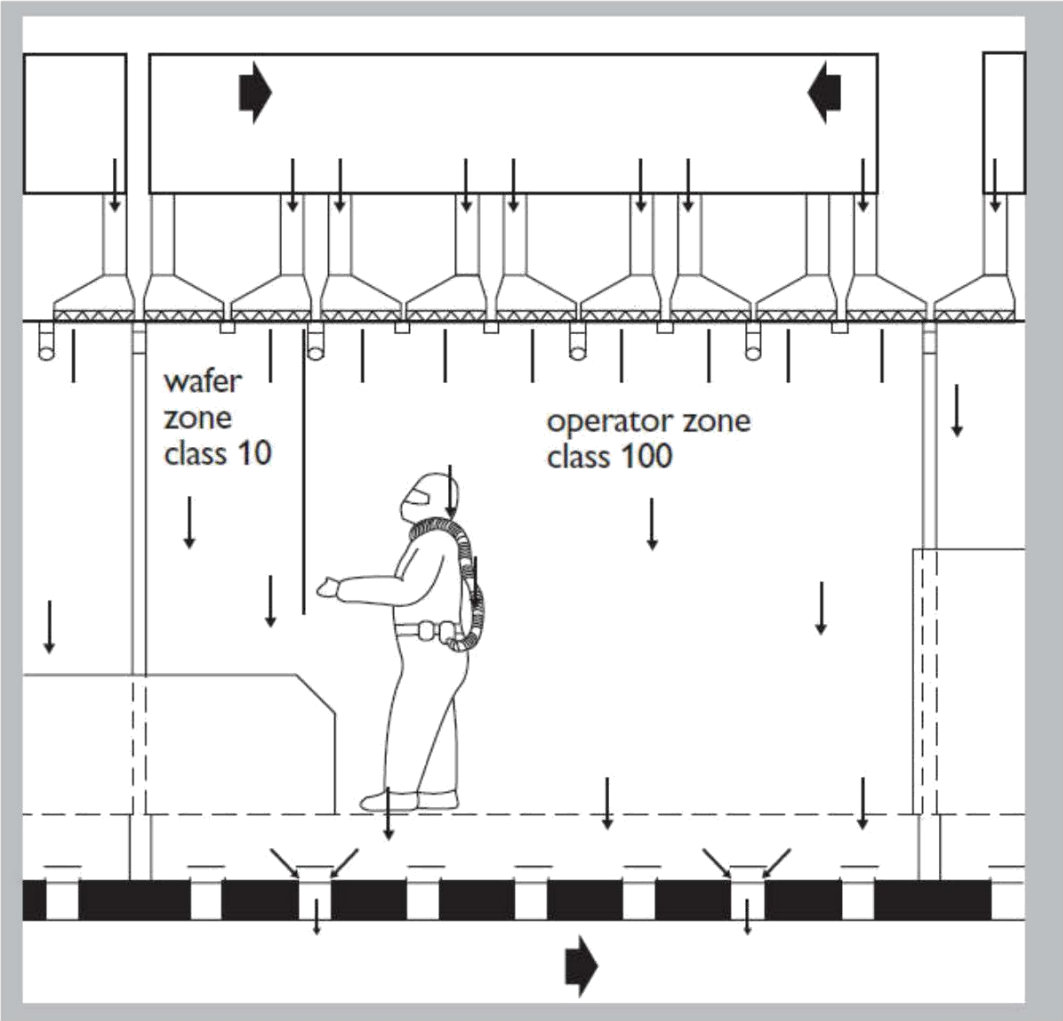

Teardrop T-bar Installation – CR388Z (track accessory)

Track accessory kit, optional, for special screw size & wiring & clean installation of T-bar

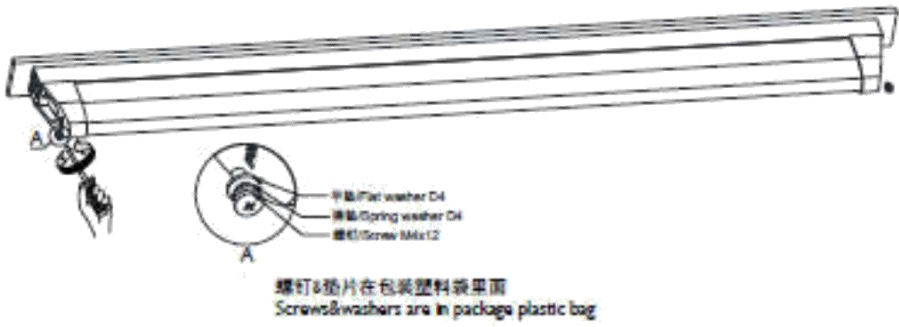
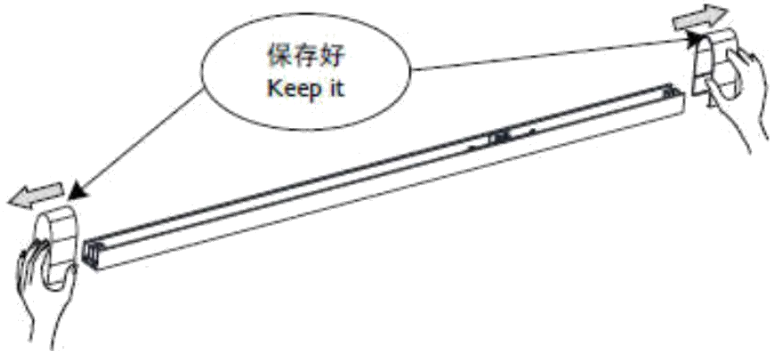

Horizontal air flow reaching class 100 or higher – CR488C

Hygeia G2 CR488C (classification 100 – 10,000)

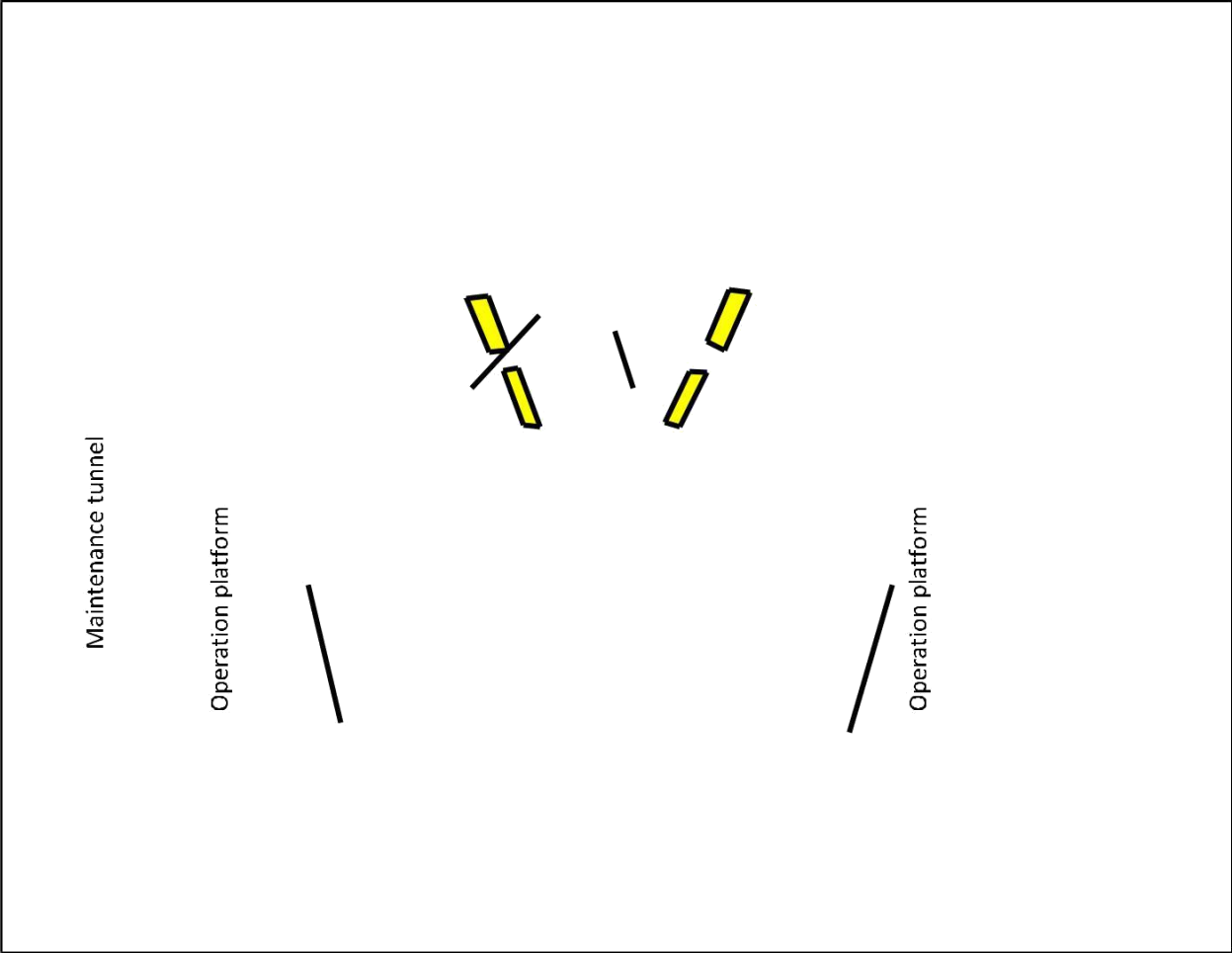

Un-unified airflow reaching class 100 or higher – CR488B

Hygeia G2 CR488B (classification 100 – 10,000)

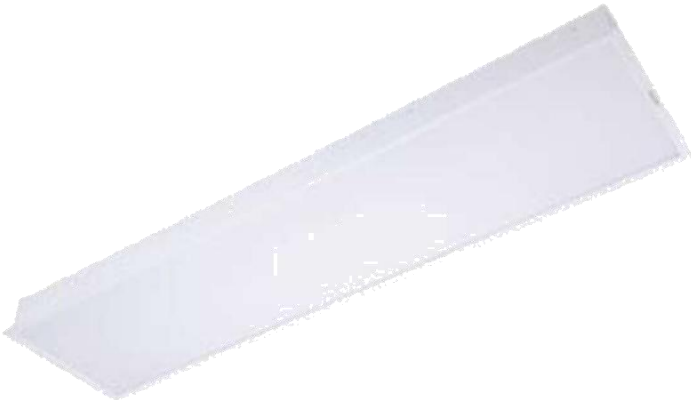
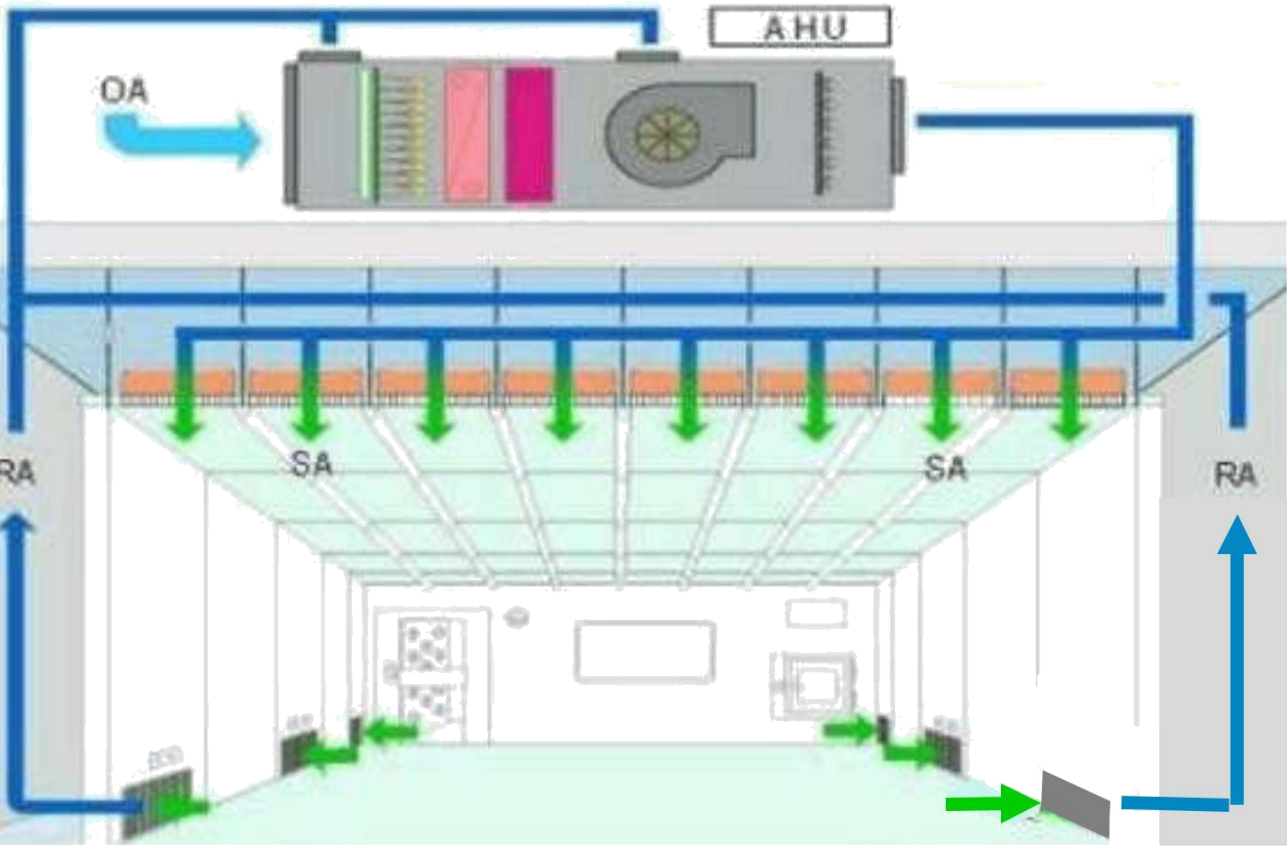

Photometric – CR388C/ CR488C

CR388C CW/NW 2000lm PSU

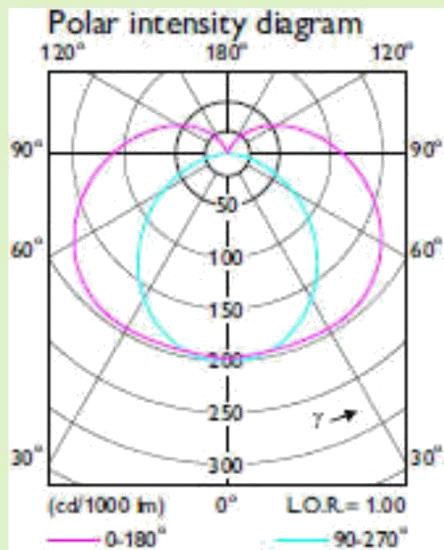

CR388C CW/NW 4000lm PSU

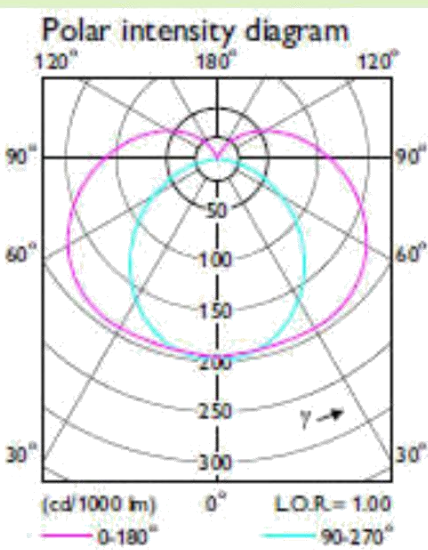

CR388C CW/NW 4000lm PSD

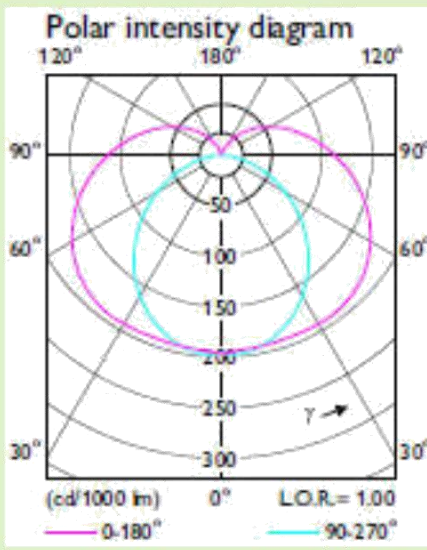

CR388C Amber 2200lm PSU

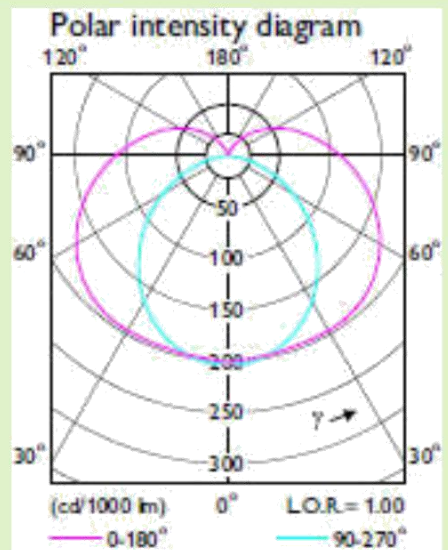

CR488C CW/NW 7500lm PSU

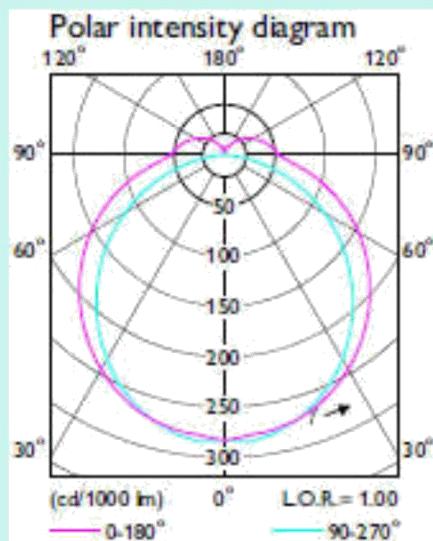

CR488C CW/NW 7500lm PSD

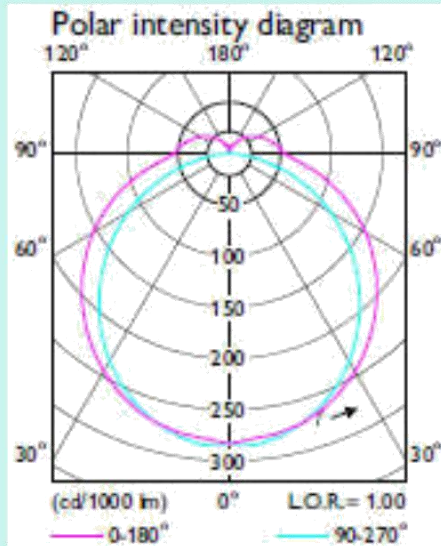

CR488C Amber 4300lm PSU

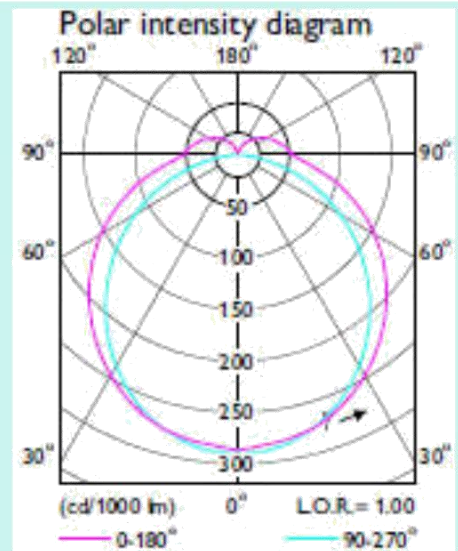

Photometric – CR388C/ CR488C

CR488B CW/NW 7400lm PSD
W30L120 CPC

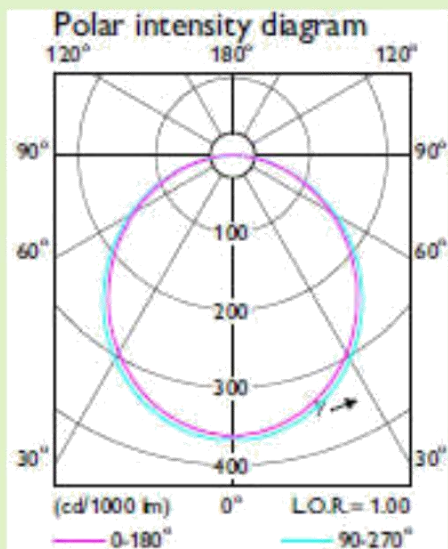

CR488B CW/NW 7500lm PSD
W60L60 CPC

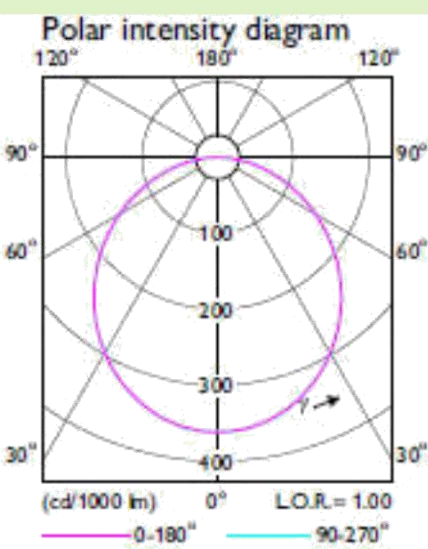

CR488B CW/NW 7400lm PSU
W30L120 CPC

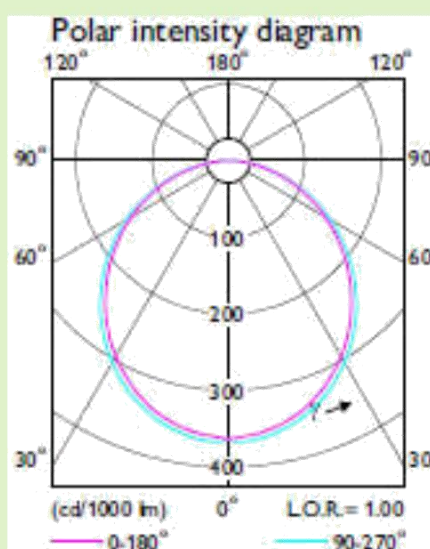

CR488B CW/NW 7500lm PSU
W60L60 CPC

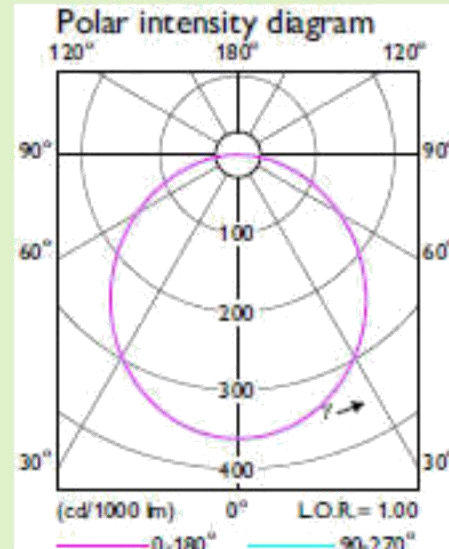

CR488B CW/NW 7400lm PSD
W30L120

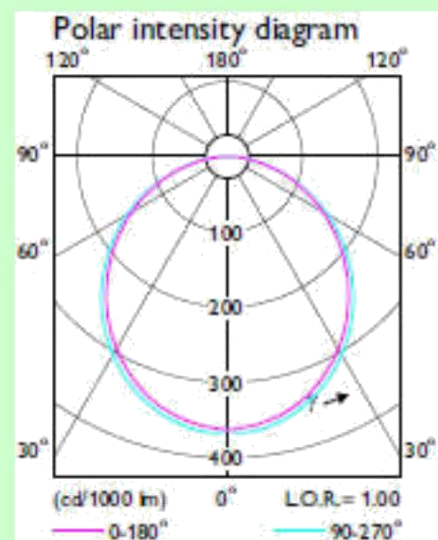

CR488B CW/NW 7500lm PSD
W60L60

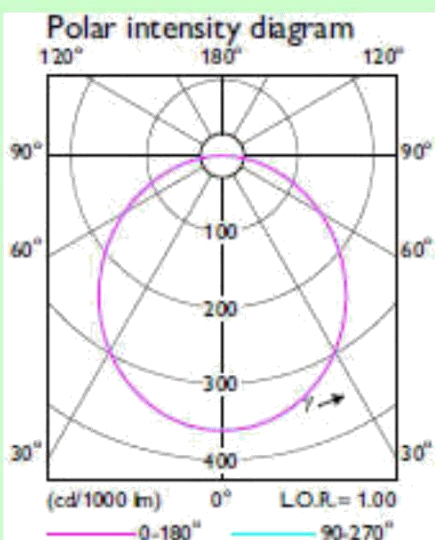

CR488B CW/NW 7000lm PSU
W30L120

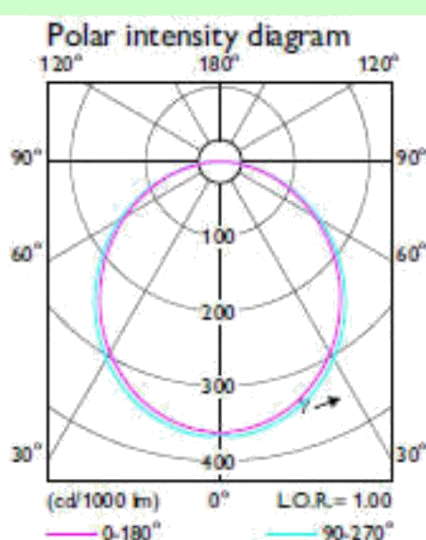

CR488B CW/NW 7500lm PSU
W60L60

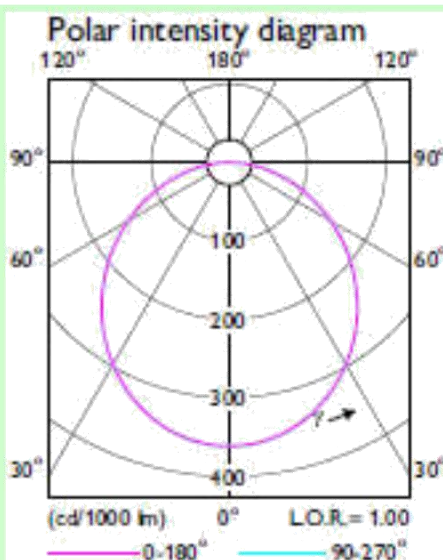

Product Datasheet– CR388C

Product	Greenperform Teardrop G2			
	CR388C			
CCT	Cool white & Natural white			Amber
Dimming	PSU	PSU	PSD	PSU
Power	16 W	32 W	39 W	21 W
CleanRoom Class	10 - 1000			
Lumen	2000 lm	3900 lm	4500 lm	2200 lm
System Efficiency	125 lm/w	120 lm/w	115 lm/w	105 lm/w
Flicker	≤ 30%	≤ 30%	≤ 4%	≤ 4%
Power factor	> 0.9			
Input Voltage	220~240V, 50/60hz			
SDCM	<5			
CRI	>80			
Photometric	symmetrical			
Dimension L x W x H :	1200 x 84 x 45 mm			
Working Temperature	0°C ~ +35°C			
Safety Class	CLASS I			
IP/IK Grade	IP40/ IK03			
Lifetime	50 K hrs (L70B50) @25°C			
Wiring Interface	Flying wire 0.3 M			
Installation	Surface			
System & Control	Fixed & Dali			
Approbation	CCC, CB			

Product Datasheet– CR488C/ CR488B

Product	Greenperform Hygeia G2				
	CR488C			CR488B	
CCT	CW & NW		Amber	CW & NW	
Dimming	PSU	PSD	PSU	PSU	PSD
Power	63 W	65 W	41 W	69 W	69W
CleanRoom Class	100 - 10,000			100 - 10,000	
Lumen	7500 lm	7500 lm	4300 lm	7500 lm	7400lm
System Efficiency	119 lm/w	115 lm/w	105 lm/w	108 lm/w	107 lm/w
Power factor	0.9	0.9	0.9	0.9	0.9
Input Voltage	220~240/50~60hz			220~240/50~60hz	
SDCM	<5			<5	
CRI	>80			>80	
Photometric	Symmetrical			Symmetrical	
IP/ IK	IP40/ IK03			IP40/ IK03	
Dimesntion L x W x H	1200 x 84 x 45 mm			597 x 597 mm	297 x 1197 mm
Working Temperature	0°C ~ +35°C			0°C ~ +35°C	
Flicker	≤ 4%			≤ 4%	
Safety Class	CLASS I			CLASS 1	
Lifetime	50 K hrs (L70B50) @25°C			50 K hrs (L70B50) @25°C	
Wiring Interface	Flying wire 0.3 M			Flying wire 0.3 M	
Installation	Surface			Recessed	
System & Control	Fixed & Dali			Fixed & Dali	
18 Approbation	CCC			CCC	

Order Information– Teardrop CR388C

Family Name: GreenPerform Traedrop G2
Catalogue Family Code: CR388C
MAG/AG/CAG: B29646705
Configurator Family: PLS Shanghai 263024
Total 7 SKUs:

Item	12NC	Description
1	911401516341	CR388C LED20 NW L120 PSU
2	911401516441	CR388C LED20 CW L120 PSU
3	911401516541	CR388C LED40 NW L120 PSU
4	911401516641	CR388C LED40 CW L120 PSU
5	911401516741	CR388C LED40 NW L120 PSD
6	911401516841	CR388C LED40 CW L120 PSD
7	911401516941	CR388C LED20 Amber L120 PSU

8	911401533741	CR388Z AC L1200
---	--------------	-----------------

Track Kit for T-bar installation

Order Information– Hygeia CR488C/ 488B

Family Name: GreenPerform Hygeia G2
 Catalogue Family Code: CR488B/ CR488C
 MAG/AG/CAG: B29313303
 Configurator Family: PLS Shanghai 263024
 Total 17 SKUs:

Item	12NC	Description
1	911401517041	CR488B LED75 NW W30L120 PSU
2	911401517141	CR488B LED75 CW W30L120 PSU
3	911401517241	CR488B LED75 NW W60L60 PSU
4	911401517341	CR488B LED75 CW W60L60 PSU
5	911401517441	CR488B LED75 NW W30L120 PSU CPC
6	911401517541	CR488B LED75 CW W30L120 PSU CPC
7	911401517841	CR488B LED75 NW W30L120 PSD
8	911401517941	CR488B LED75 CW W30L120 PSD
9	911401518041	CR488B LED75 NW W60L60 PSD
10	911401518141	CR488B LED75 CW W60L60 PSD
11	911401518241	CR488B LED75 NW W30L120 PSD CPC
12	911401518341	CR488B LED75 CW W30L120 PSD CPC
1	911401518441	CR488C LED70 NW L120 PSD
2	911401518541	CR488C LED70 CW L120 PSD
3	911401518641	CR488C LED40 Amber L120 PSU
4	911401517641	CR488C LED70 NW L120 PSU
5	911401517741	CR488C LED70 CW L120 PSU

Phase-out Pre Announcement – Pruning G1 & Conventional

Phase in/ Phase Out Plan



824110120991	TMX285 1xTL5-49W HFS DE
824110121001	TMX285 1xTL5-28W HFS DE
824110121011	TTX285 281 DE
824110121021	TTX285 491 DE
910403315480	TTX285 361
910403315580	TTX285 362
910403315680	TTX285 363
910403315780	TTX285 581
910403315880	TTX285 582
910403315980	TTX285 CP
911400863080	TMX285 1xTL-D36W HFP 220-240/50-60
911400863180	TMX285 1xTL-D36W HFS 220-240/50-60
911400863280	TMX285 1xTL-D58W HFP 220-240/50-60

911401588501	CR385C LED20/NW
911401588301	CR385C LED40/NW
911401588401	CR385C LED40/Y

Cleanroom Teardrop & Hygeia **G2** Commercial Release

- **2017 August**

Cleanroom Teardrop & Hygeia Conventional & G1 Phase-out

- **2018 January, last order**
- **2018 March, SAP codes close**

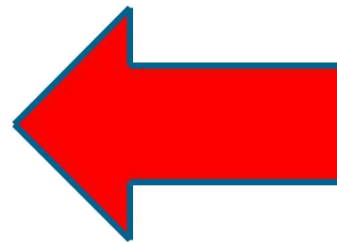

Phase Out

